



For Earth, For Life
Kubota

R

KUBOTA WHEEL LOADER R540/R640

Kubota's next-generation R540 and R640 wheel loaders bring you comfort, easy operation, and all the power you need.



Comfort, easy operation and all the power you

Kubota's next-generation R540 and R640 wheel loaders are built to get the job done quickly, easily, and efficiently. They're built for comfort, with a new, high-visibility cabin. They're also built for simple and productive operation, even by operators with novice experience. And they're built for performance, with enhanced productivity features and power to spare.



ion,
need.



KUBOTA WHEEL LOADER

R540/R640

OPERATOR COMFO

Redesigned inside and out, both the R540 and R640 wheel loaders boast a fully enclosed glass cabin for improved visibility, as well as a more ergonomic control layout.



A Full-suspension seat

A full-size, full-suspension adjustable seat enhances operator comfort. The padded seat can be moved forward or back for optimum comfort.

B Adjustable right wrist rest

This feature reduces fatigue by reducing arm movement and allowing you to more easily operate the hand lever.

C Tilt steering

With the flick of a lever, the steering wheel can be tilted up or down to the most comfortable and efficient position for operators of all sizes.

New interior design

The spacious cabin's ergonomic layout is designed to keep you working comfortably from start to finish.

Air conditioning

A powerful heating/cooling system and eleven vents provide optimum comfort on the coldest winter and hottest summer days.

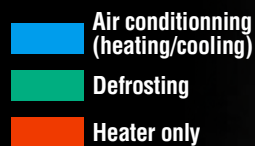

RT / EASE OF USE

Full opening Right window

The window on the right side of the cabin opens fully to improve ventilation as well as communication with workers outside.

High-visibility cabin

Fully enclosed in glass, the high-visibility cabin offers the operator a panoramic perspective of the environment outside, with the pallet fork tips clearly visible from the driver's seat. The full glass door, and wide opening window provide excellent visibility to the left and right, while the rear window offers an unobstructed view when traveling in reverse.

ROPS/FOPS cab and canopy

Manufactured and attached at the Kubota factory, both the Roll-Over Protective Structure (ROPS) and Falling Object Protective Structure (FOPS) meet the applicable ISO, SAE standards and OSHA regulations.



PERFORMANCE

Long reach and excellent lifting power ensure superior performance for a wide range of loader tasks.



R540: 2965 lbs
R640: 3406 lbs
(Max. payload 50%, bucket)

Above figures are based on the machine with wide tires and SSL type quick coupler.



R540:
10' 7" (3230 mm)

R640:
10' 8" (3255 mm)

Working range

A long reach and high clearance make all types of material handling jobs easy. The high clearance lets you load trucks with ease, while the superior reach makes pallet fork operations faster and more efficient.

Arm tilt / Parallel movement

Transporting a fully loaded pallet with the pallet fork, Kubota's arm tilt/parallel movement structure keeps the load upright and steady, even while raising or lowering the lift arm.

Powerful lifting capacity

An improved lifting force provides smooth operation for both R540 and R640, while lifting and handling material in a variety of applications.

Multi-function operating lever

All major loader functions are on a single lever that is easy to operate with just one hand, both on the R540 and R640. The 2-step speed control switch lets you quickly change speeds, allowing you to operate at optimum efficiency for the task at hand.

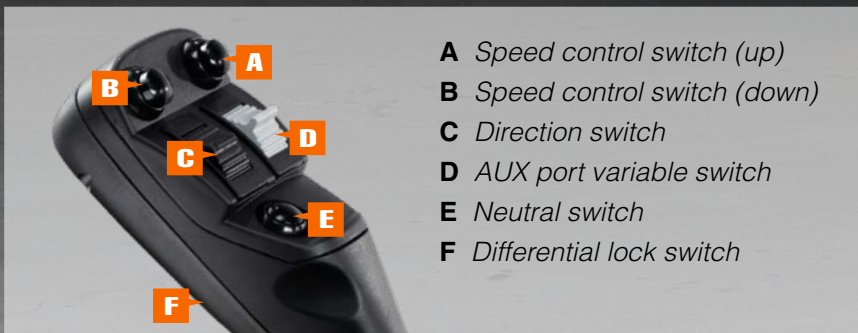

Kubota original DI engine with CRS and DPF muffler

The new Kubota's V2607 direct-injection engine is equipped with CRS and with a new and improved DPF which reduces maintenance by increasing the service intervals for both the regeneration filter and ash cleaner.

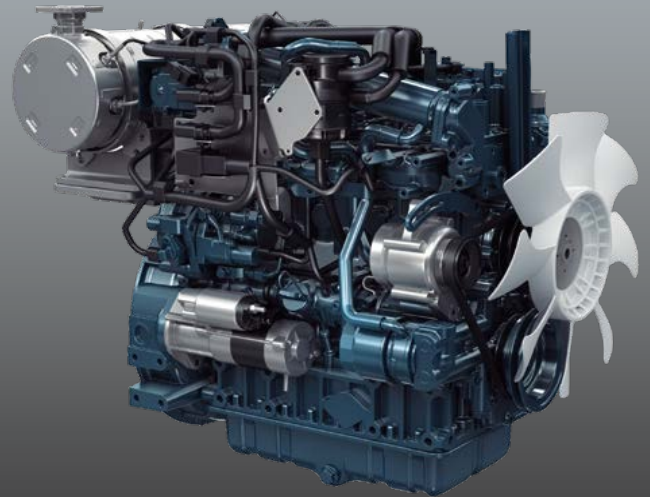

**GROSS ENGINE
OUTPUT**

R540: 50.9 HP

R640: 64.3 HP



Differential lock (100% On demand, front & rear)

Should the wheels start to slip, simply press the differential lock switch to immediately engage both front and rear wheels. The result is positive slip-free traction.

SERVICE

Simple maintenance ensures that your R540 and R640 loaders are productive.



Digital diagnostic indicators

A bright easy-to-read digital diagnostic indicator keeps you fully informed of critical loader and engine conditions.

■ Error display

⊠ E: 014 $\frac{n/min}{h}$

Hydraulic oil temperature has reached a specified level

⊠ E: 001 $\frac{n/min}{h}$

Meter ECU communication error

⊠ E: 025 $\frac{n/min}{h}$

Parking brake error

⊠ E: 016 $\frac{n/min}{h}$

Fuel sensor system error

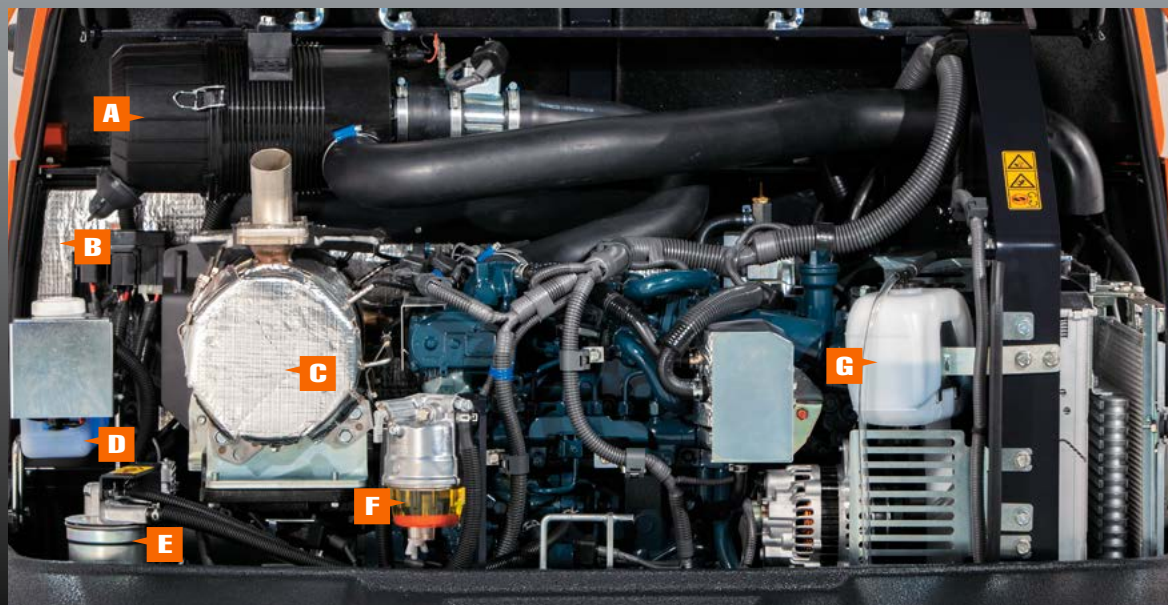

Easy maintenance

The engine bonnet at the rear opens wide, providing quick and easy access to the machine's main service areas. Items that require routine maintenance and service are within easy reach for fast and simple servicing. Quick-open panels on the right and left sides provide speedy access to the fuel refill (right side) and battery (left side). Other areas of the R540 and R640 are also easy to service and maintain.

- A DUAL ELEMENT AIR CLEANER**
- B BATTERY**
- C DIESEL PARTICULATE FILTER (DPF) MUFFLER**
- D WASHER TANK**
- E FUEL FILTER**
- F WATER SEPARATOR**
- G RESERVE TANK**



Easy transportation

With an overall height of 8'2" or less, the R540 and R640 fit easily under road bridges for fast and efficient transportation between job sites. Six tie-down points allow simple yet secure attachment to a truck bed for safety during transportation.

New LED work lights

Bright LED work lights provide plenty of illumination for nighttime tasks.



Standard equipment

Safety

- 6 Tie down points
- Lift arm support
- Towing pin

Working equipment

- 2 Head lights (Headlights and Signal Lights)
- Rear combination lights
(Turn signal, Tail light, Brake light, Backup light)

Operator's space

- Canopy (ROPS / FOPS Level1)
- Weight-adjustable suspension seat (PVC seat) with left arm rest and back rest
- Retractable seatbelt
- Adjustable right wrist rest
- Digital panel with diagnostic function
- Side mirrors
- 12V power outlet
- Tool storage space - Canopy models
- Tilt steering
- Cup holder

Engine/Fuel system

- KUBOTA original engine
- Double-element air cleaner

- Fuel level indication buzzer
- Fuel / water separator
- Separate fuel filter

Travel system

- Differential lock
(100% on demand, front and rear)
- Wet type disc brake
- Negative brake (parking brake)
- Wide tire (R540: 365/70R18 / R640: 405/70R18)

Hydraulic system

- Hydrostatic transmission
- Multi-function operating lever with AUX proportional control
- Hydraulic lock switch
- Inching and brake pedal (left)
- Hydraulic quick coupler switch
- Loader float switch

Others

- Maintenance free battery
- Grease gun holder
- Radio ready

Optional equipment

- Cab with air conditioner
- Beacon light
- Inching and brake pedal (right)
- Kubota Shockless Ride (KSR)
- Tool box for cab models
- Rear working LED lights
- Various buckets and other attachment
- Block heater
- 3" retractable seat belt
- Hydraulic Euro-type coupler
- Hydraulic SSL-type coupler
- Mechanical SSL-type coupler

Stay connected with **KubotaNOW**

KubotaNOW telematics gives you the right information, when and where you need it. To access KubotaNOW telematics information, download the myKubota app and stay connected to your Kubota machine. Get information like hours, fuel level, location, temperatures, error codes, and more.



Working range

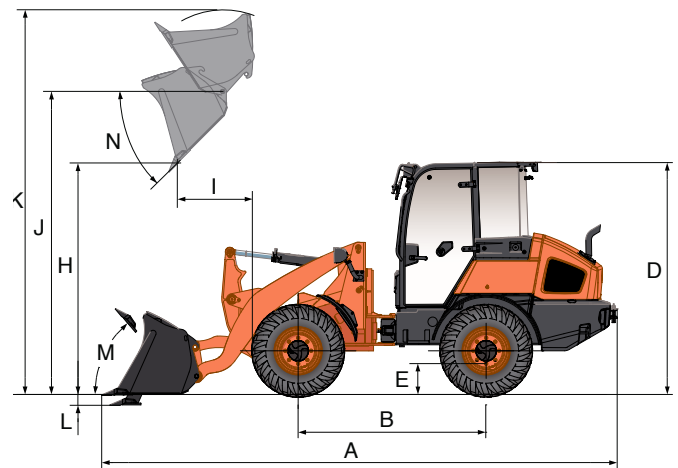
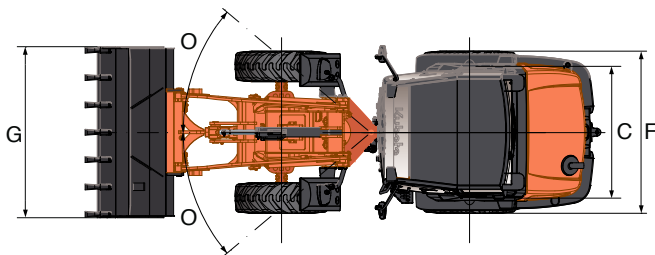

Model			R540	R640
A	Overall length	ft.in. (mm)	17' 9" (5400)	18' 0" (5480)
B	Wheelbase	ft.in. (mm)	6' 7" (2000)	
C	Tread	ft.in. (mm)	4' 5" (1355)	4' 7" (1400)
D	Overall height (canopy / cabin)	ft.in. (mm)	8' 1" (2455) / 8' 1" (2475)	8' 2" (2480) / 8' 2" (2500)
E	Ground clearance	in. (mm)	12.6" (320)	13" (340)
F	Overall width (outside of tires)	ft.in. (mm)	5' 8" (1720)	5' 11" (1805)
G	Overall width (bucket)	ft.in. (mm)	6' 2" (1867)	6' 4" (1918)
H	Dumping clearance	ft.in. (mm)	8' 0" (2430)	7' 10" (2385)
I	Dumping reach	ft.in. (mm)	2' 7" (780)	2' 8" (825)
J	Max. hinge pin height	ft.in. (mm)	10' 7" (3230)	10' 8" (3255)
K	Max. lifting height	ft.in. (mm)	13' 5" (4080)	13' 8" (4175)
L	Digging depth	in. (mm)	6.1" (155)	5.1" (130)
M	Tilt back angle (at traveling position)	Deg.	52	
N	Dumping angle	Deg.	44	
O	Articulation angle	Deg.	40	

Specifications

Model		R540	R640		
Type of ROPS / FOPS		CANOPY / CAB			
Engine	Model	V2607-CR-E5-WL	V2607-CR-TE5-WL		
	Emission certification	Tier4 Final			
	Output (SAE J1995 gross)	HP (kW) @ rpm	50.9 (38.0) @ 2400	64.3 (48.0) @ 2400	
	Output (SAE J1349 net)	HP (kW) @ rpm	47.9 (35.7) @ 2400	61.1 (45.6) @ 2400	
	Displacement	cu.in. (cc)	160 (2615)		
Transmission	Type	Hydrostatic transmission			
Dimensions	Overall length	ft.in. (mm)	17' 9" (5400)	18' 0" (5480)	
	Overall height	ft.in. (mm)	8' 1" (2455) / 8' 2" (2475)	8' 2" (2480) / 8' 2" (2500)	
	Overall width (w/o bucket)	ft.in. (mm)	5' 8" (1720)	5' 11" (1805)	
	Ground clearance	in. (mm)	12.6" (320)	13" (340)	
Auxiliary circuit	Auxiliary hydraulic flow	gpm (ℓ/min.)	14.2 (54)	17.8 (67.2)	
	Auxiliary hydraulic pressure	psi (Mpa)	2683 (18.5)	2973 (20.5)	
Drive system	Tire size		365/70R18	405/70R18	
	Travel speed	mph (km/h)	0 – 12.4 (0 – 20.0)		
	Max. traction force	lbs. (kN)	6541 (29.1)	8588 (38.2)	
	Front/Rear axle traction lock		Diff-lock (both axles)		
	Articulation angle	deg.	40 (each direction)		
	Angle of rear frame oscillation	deg.	±8		
	Loader clearance circle	ft.in. (mm)	13' 8" (4175)	13' 10" (4221)	
	Turning radius track circle	ft.in. (mm)	11' 11" (3620)	12' 0" (3664)	
	Brakes	Service	Enclosed wet disc		
		Parking	Spring applied hydraulic released wet disc		
Lifting specifications	Tipping load (straight)	with bucket	lbs. (kg)	6437 (2920) / 6768 (3070)	7452 (3380) / 7760 (3520)
		with pallet forks	lbs. (kg)	4960 (2250) / 5202 (2360)	5820 (2640) / 6063 (2750)
	Tipping load (full turn)	with bucket	lbs. (kg)	5644 (2560) / 5930 (2690)	6526 (2960) / 6812 (3090)
		with pallet forks	lbs. (kg)	4365 (1980) / 4586 (2080)	5115 (2320) / 5313 (2410)
	Operating capacity	with bucket (50%)	lbs. (kg)	2822 (1280) / 2965 (1345)	3263 (1480) / 3406 (1545)
		with pallet forks (60%)	lbs. (kg)	2624 (1190) / 2756 (1250)	3064 (1390) / 3197 (1450)
Operational specifications	Standard bucket capacity	yd ³	0.85	0.94	
	Breakout force	lbs. (kN)	7761 (34.5)	8526 (37.9)	
	Lifting capacity at ground level	lbs. (kN)	6767 (30.1)	8161 (36.3)	
	Loader raise / lower time	sec.	6.5 / 4.5	5.8 / 3.9	
Fuel tank	gal. (ℓ)	18.5 (70)			
Hydraulic system	gal. (ℓ)	14.5 (55)			
Hydraulic reservoir	gal. (ℓ)	10.3 (39)			
Operating weight (Including operator weight @ 165lbs.)	lbs. (kg)	9888 (4485) / 10285 (4665)	11177 (5070) / 11563 (5245)		

Pallet fork specifications

Model		R540	R640	
Fork length		in. (mm)		
		48" (1220)		
A1	Overall length	ft.in. (mm)	19' 10" (6041)	19' 9" (6026)
B1	Height of forks at Max. reach	ft.in. (mm)	4' 7" (1387)	4' 8" (1412)
C1	Height of forks at Max. height	ft.in. (mm)	10' 0" (3053)	10' 2" (3078)
D1	Reach at ground level	ft.in. (mm)	3' 1" (941)	2' 11" (896)
E1	Max. reach	ft.in. (mm)	4' 8" (1410)	4' 7" (1387)
F1	Reach at Max. height	ft.in. (mm)	2' 2" (647)	2' 1" (622)

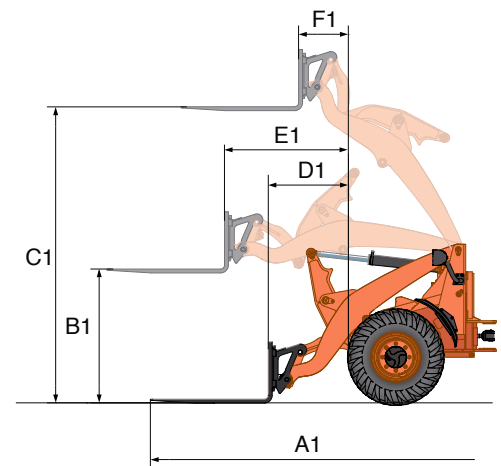

Note: The above dimensions are based on the machine with wide tires, SSL type quick coupler, standard bucket/pallet fork and ROPS/FOPS canopy and cabin.

Kubota Tractor Corporation reserves the right to change the stated specifications without notice. This brochure is for descriptive purposes only and reasonable efforts were used to set forth the contained information; some items shown may be optional and some products shown may not be available at all dealerships. Kubota disclaims all representations and warranties, express or implied, or any liability from the use of this brochure. For complete warranty, safety and product information, consult your local Kubota dealer and the operator's manual. Power (HP/KW) and other specifications are based on various standards or recommended practices. For your safety, Kubota strongly recommends the use of a Rollover Protective Structure (ROPS) and seat belt in almost all applications. This brochure is intended for the United States and US territories only. For information regarding Kubota products or services outside these areas, see Kubota Corporation's global web site. Kubota does not provide parts, warranty or service for any Product which is re-sold or retailed in any country other than the country for which the Product(s) were designed or manufactured.

★ All images shown are for brochure purposes only.

When operating the wheel loader, wear clothing and equipment in accordance to local legal and safety regulations.



KUBOTA TRACTOR CORPORATION

1000 Kubota Drive, Grapevine, TX 76051 Tel 888-4 KUBOTA

Visit our web site at: www.kubotausa.com

©2021 Kubota Corporation



**Kubota
Genuine Parts**
for maximum
performance,
durability and
safety